

EMBFSCG-23-25-BK

Conduit fitting with cable gland, straight, plastic/brass, RAL 9005, NW23

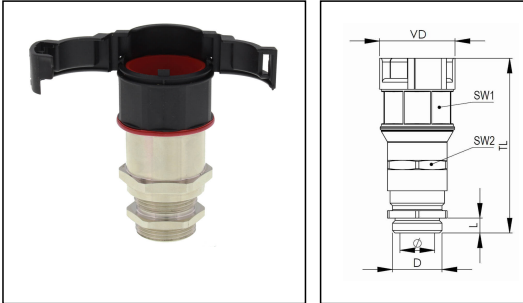

Products may differ in size, colour and appearance to those shown. If you require further information or customisation, please contact us directly.



Material Conduit fitting	polyamide UL94-V0
Material Connection thread	Brass nickel-plated
Material sealing gasket	TPU
Protection class	IP68, IP66
Temp. range min	-40 °C
Temp. range max	100 °C
Operational areas	EN 45545 - Railway
NW	23
Thread type	M
Ø Connection thread D	25
Lead	1,5
Length screw-in thread L	7 mm
Ø cable diameter min	9 mm
Ø cable diameter max	17 mm
Ø closure VD	42,3 mm
Ø inside	17 mm
Key width SW1	36 mm
Key width SW2	29 mm
Total length TL	75,6 mm - 81,2 mm
Type of conduit fitting	straight
Product Color	RAL 9005
Type	EMBFSCG-23-25-BK
Order no. RAL 9005	10107383
Packing unit	25
EAN number	4007686042849

Your Contact:

WISKA Hoppmann GmbH

Kisdorfer Weg 28 · 24568 Kaltenkirchen · Germany

☎ +49-4191-508-0 · 📠 +49-4191-508-209

contact@wiska.de · www.wiska.com

Tariff number	74122000
ETIM-Classification	EC001176

Recommended accessories

EMMU 25	10063144
BCA-S-23-BK	10107076
BCAV-S-23-BK	10107091
BCIV-S-23-BK	10107108
BCA-23-D-BK	10107123
BCAV-23-D-BK	10107137
BCAB-L-23-BK	10109186
BCAV-H-23-BK	10109203
BCIB-H-23-BK	10109225

23.05.2026

Your Contact:

WISKA Hoppmann GmbH

Kisdorfer Weg 28 · 24568 Kaltenkirchen · Germany

☎ +49-4191-508-0 · 📠 +49-4191-508-209

contact@wiska.de · www.wiska.com

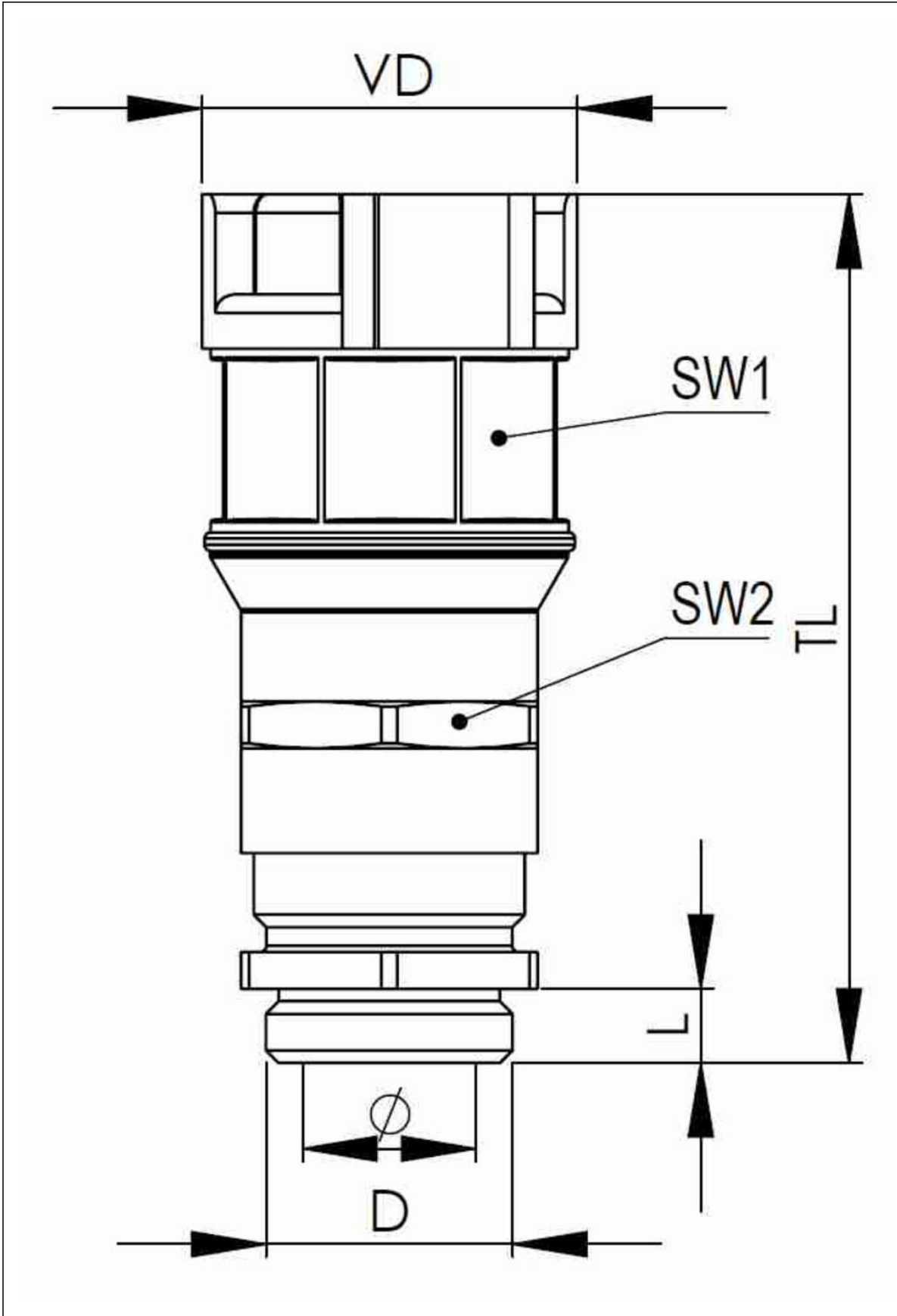

Your Contact:

WISKA Hoppmann GmbH

Kisdorfer Weg 28 · 24568 Kaltenkirchen · Germany

☎ +49-4191-508-0 · 📠 +49-4191-508-209

contact@wiska.de · www.wiska.com