

PMSKV 9-16 LT

Cable gland, LowTemp, brass nickel-plated, Pg 9

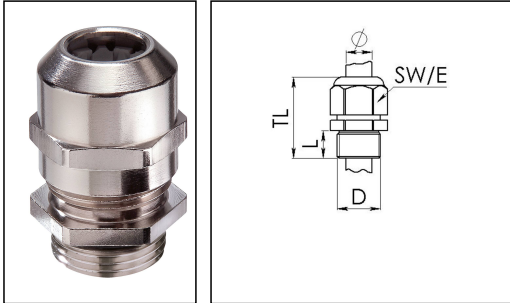

Products may differ in size, colour and appearance to those shown. If you require further information or customisation, please contact us directly.



Material cable gland	Brass nickel-plated
Material clamping cage	Polyamide
Material sealing gasket	Silicone
Temp. range min	-60 °C
Temp. range max	100 °C
Protection class	IP69, IP68 (5 bar 30 min)
Thread type	PG
Ø Connection thread D	9
Length screw-in thread L	5 mm
Ø cable diameter min	4,5 mm
Ø cable diameter max	10 mm
Key width SW	20 mm
Collar diameter (E)	22 mm
Total length TL	26 mm - 34 mm
Type of cable anchorage	A
Install. torques fitting	4 N m
Install. torques cap nut	7,5 N m
Impact category	6
Surface	Nickel-plated
Order no. nickel-plated	10107523
Packing unit	50
Type	PMSKV 9-16 LT
Tariff number	74198090
EAN number	4007686045680
ETIM-Classification	EC000441

Your Contact:

WISKA Hoppmann GmbH

Kisdorfer Weg 28 · 24568 Kaltenkirchen · Germany

☎ +49-4191-508-0 · 📠 +49-4191-508-209

contact@wiska.de · www.wiska.com

Recommended accessories

MMU 9

10062142

23.05.2026

Your Contact:

WISKA Hoppmann GmbH

Kisdorfer Weg 28 · 24568 Kaltenkirchen · Germany

 +49-4191-508-0 ·  +49-4191-508-209

contact@wiska.de · www.wiska.com



Your Contact:

WISKA Hoppmann GmbH

Kisdorfer Weg 28 · 24568 Kaltenkirchen · Germany

☎ +49-4191-508-0 · 📠 +49-4191-508-209

contact@wiska.de · www.wiska.com