

VARITAIN® PI 01/FS/FS/32A/10kA/LED/G

Reefer container socket 32A 10kA 440V 3h 1-gang, stainless steel, RAL 7035

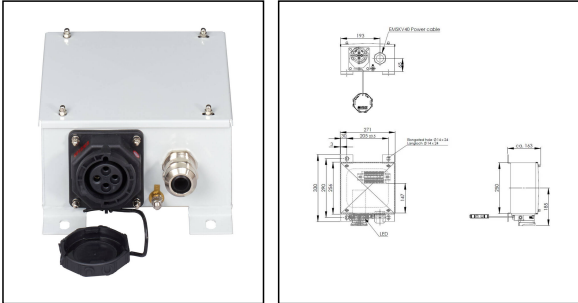

Products may differ in size, colour and appearance to those shown. If you require further information or customisation, please contact us directly.



WISKA-Order no.	10108621
Type	VARITAIN® PI 01/FS/FS/32A/10kA/LED/G
Material	Stainless steel 1.4301 (V2A)
Material protective cap	Polyamide
Socket insert	3 - poles + PE
Clock face position	3h
Number of sockets	1
Breaking capacity	10 kA
Voltage max. (V)	440 V
Type of Voltage	AC
Current	32 A
Protection class	IP66 / IP67
Operational areas	Outdoor
Temp. range min	-25 °C
Temp. range max	45 °C
Type of cable gland	EMSKV-RDE 40/EE36-26
Ø cable diameter min	12 mm
Ø cable diameter max	28 mm
Mounting	Surface mounting, Wall
External dimensions LxWxH	265x250x129mm
Colour	RAL 7035
Weight	5,45 kg
Approval	DNV-GL
Variations	on request
Tariff number	85366990

Your Contact:

WISKA Hoppmann GmbH

Kisdorfer Weg 28 · 24568 Kaltenkirchen · Germany

☎ +49-4191-508-0 · 📠 +49-4191-508-209

contact@wiska.de · www.wiska.com

Spare parts

SP-VARI-OTE-PI/CL	22000391
SP-CAP NUTS M6	22000402
SP-BC/FS-CEE/BELT/32A	22000403
SP-VARI-PI/SM/LED/10kA/NUTS	22000426
SP-VENTPLUG 12	22000430
SP-LID GASKET	22000431
SP-VARI/TB 35mm²	22000615
SP-VARI-PI/SM/LED	22000640
SP-VARI-PI/LED/10kA/BC/NUTS	22000668
SP-VARI-PI/LED CIRCUIT BOARD	22000908

23.05.2026

Your Contact:

WISKA Hoppmann GmbH

Kisdorfer Weg 28 · 24568 Kaltenkirchen · Germany

☎ +49-4191-508-0 · 📠 +49-4191-508-209

contact@wiska.de · www.wiska.com

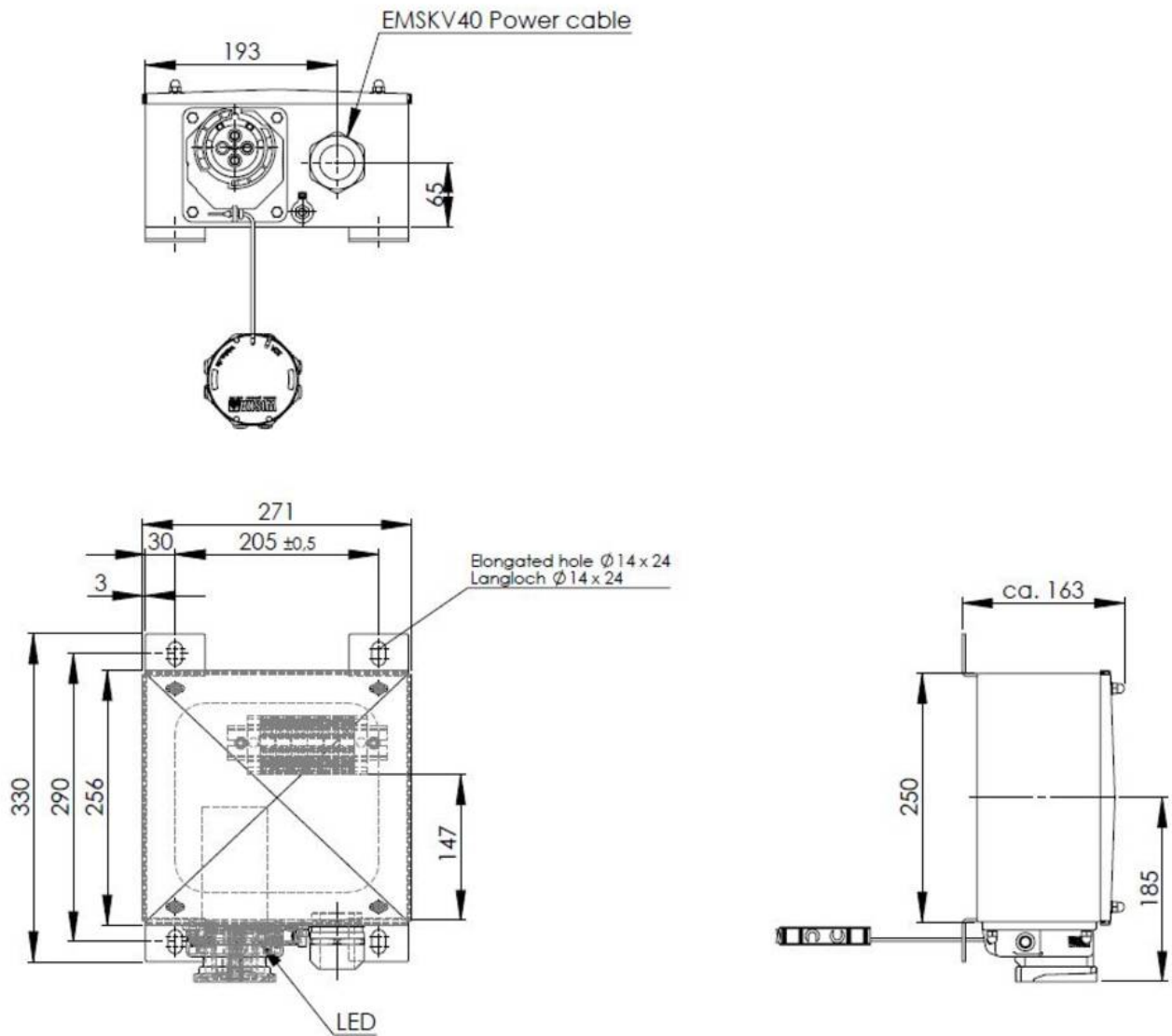

Your Contact:

WISKA Hoppmann GmbH

Kisdorfer Weg 28 · 24568 Kaltenkirchen · Germany

☎ +49-4191-508-0 · 📠 +49-4191-508-209

contact@wiska.de · www.wiska.com