

EMBMFS-S-40-50

Metal Conduit fitting brass nickel-plated, NW40/M50, smooth

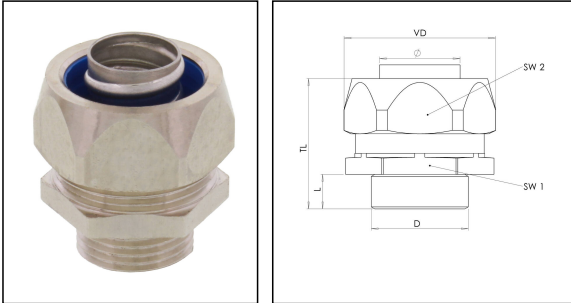

Products may differ in size, colour and appearance to those shown. If you require further information or customisation, please contact us directly.



Material Conduit fitting	Brass nickel-plated
Material sealing gasket	PA
Protection class	IP67
Temp. range min	-45 °C
Temp. range max	145 °C
Operational areas	Mechanical plant engineering
NW	40
Thread type	M
Ø Connection thread D	50
Lead	1,5
Length screw-in thread L	14 mm
Ø closure VD	69 mm
Ø inside	39,5 mm
Key width SW1	60 mm
Key width SW2	62 mm
Total length TL	54,5 mm
Using for Conduit	smooth
Torque nozzle	35 N m
Torque cap nut	35 N m
Type	EMBMFS-S-40-50
WISKA-Order no.	10109115
Packing unit	2
EAN number	4007686081213
Tariff number	74122000
ETIM-Classification	EC001180

Your Contact:

WISKA Hoppmann GmbH

Kisdorfer Weg 28 · 24568 Kaltenkirchen · Germany

☎ +49-4191-508-0 · 📠 +49-4191-508-209

contact@wiska.de · www.wiska.com

Recommended accessories

BMCG-PVC-S-40-BK	10109029
BMCG-PVC-S-40-LG	10109037
BMCG-PVC-S-40-BK-GT	10109045
BMCG-PVC-S-40-LG-GT	10109053

23.05.2026

Your Contact:

WISKA Hoppmann GmbH

Kisdorfer Weg 28 · 24568 Kaltenkirchen · Germany

 +49-4191-508-0 ·  +49-4191-508-209

contact@wiska.de · www.wiska.com

