

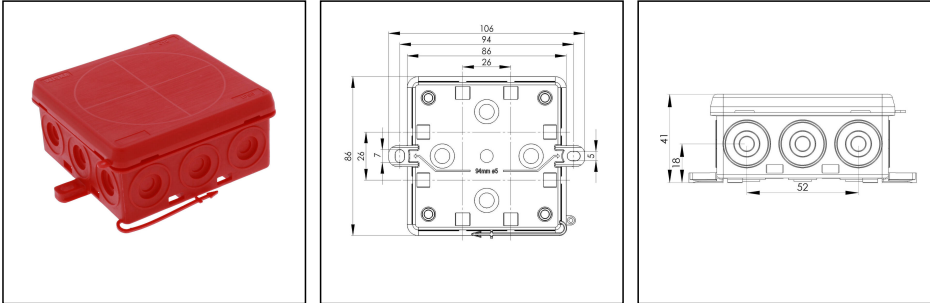

KA 012/5 RD

Junction box 86x86x41mm, plastic, RAL 3000, with terminal block



Products may differ in size, colour and appearance to those shown. If you require further information or customisation, please contact us directly.



Material	Polyethylene / Polypropylene
Protection class	IP55
Temp. range min	-30 °C
Temp. range max	60 °C
Temperatures during install.	-5 °C - 60 °C
Glow wire test	750 °C
Voltage	400 V
Rated cross section	4 mm ²
Terminals/poles	5-pole, 4,0 mm ²
Fixing	2 external mounting feet
Ø cable diameter min	7 mm
Ø cable diameter max	12 mm
External dimensions LxWxH	86 x 86 x 41 mm
Using for cable gland	
Product Color	RAL 3000
WISKA-Order no.	10109592
Type	KA 012/5 RD
Packing unit	10
EAN number	4007686095029
Tariff number	85369010
ETIM-Classification	EC002600

Remarks:

Fixture: with cable ties, 2 external mounting feet

Your Contact:

WISKA Hoppmann GmbH
Kisdorfer Weg 28 · 24568 Kaltenkirchen · Germany
☎ +49-4191-508-0 · 📠 +49-4191-508-209
contact@wiska.de · www.wiska.com

Equipment:

- 12 self-sealing, cutable cable entries at the side, 4 on the bottom
- captive cover
- with terminal block 5-poles, 4mm²

Recommended accessories

ZER 4-12 LG	10109800
ESD 30 LG	10109875
ESV LG	10109876
EDV LG	10109877
ZER 11-18 LG	10110766

Spare parts

SP-KT 11/5 Terminal block	22000409
---------------------------	----------

23.05.2026

Your Contact:

WISKA Hoppmann GmbH

Kisdorfer Weg 28 · 24568 Kaltenkirchen · Germany

☎ +49-4191-508-0 · 📠 +49-4191-508-209

contact@wiska.de · www.wiska.com

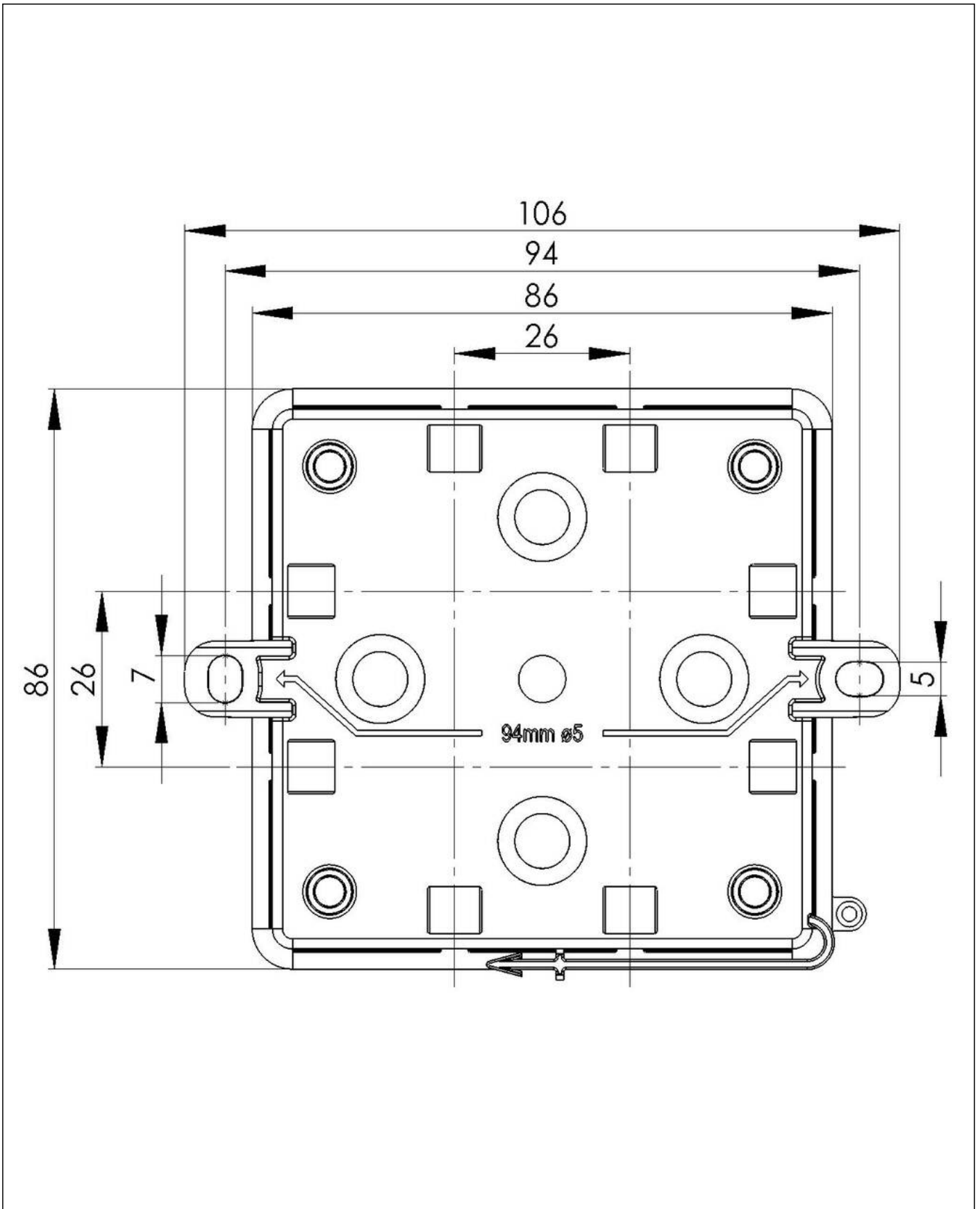

Your Contact:

WISKA Hoppmann GmbH

Kisdorfer Weg 28 · 24568 Kaltenkirchen · Germany

☎ +49-4191-508-0 · 📠 +49-4191-508-209

contact@wiska.de · www.wiska.com

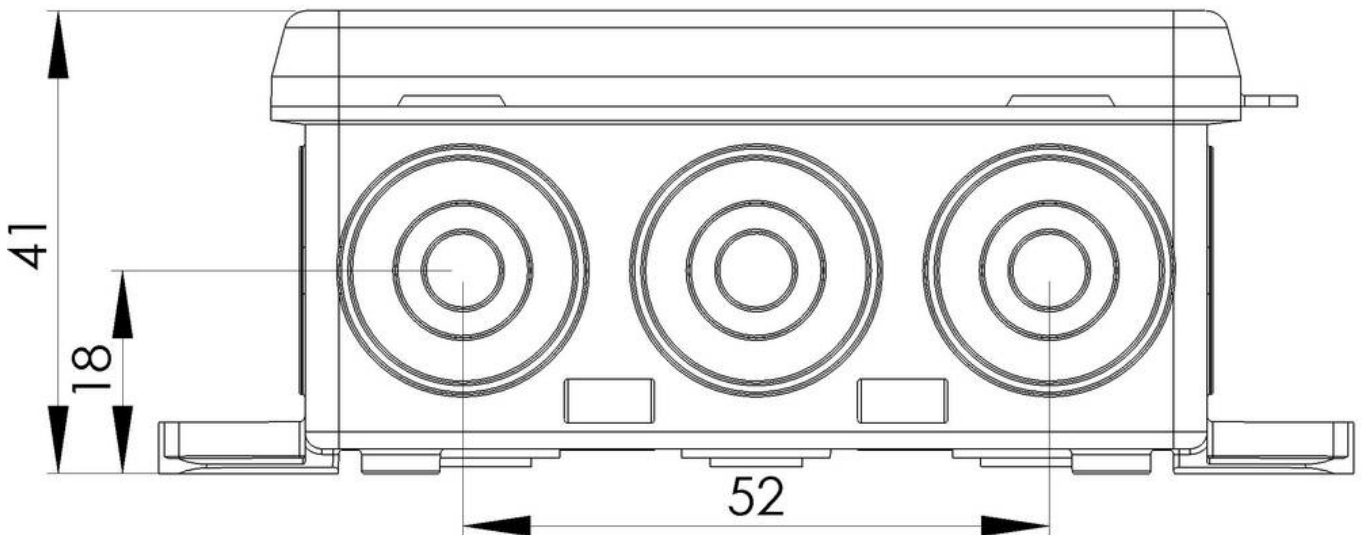

Your Contact:

WISKA Hoppmann GmbH

Kisdorfer Weg 28 · 24568 Kaltenkirchen · Germany

☎ +49-4191-508-0 · 📠 +49-4191-508-209

contact@wiska.de · www.wiska.com