

BFC-29-29-BK

Adaptor-Connector, polyamide, RAL 9005, NW 29

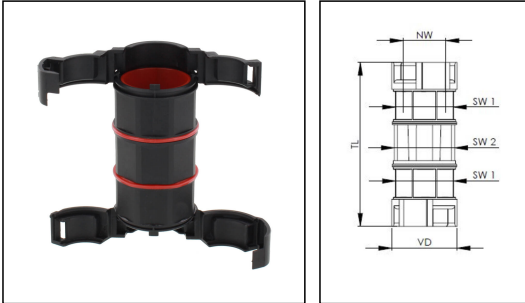

Products may differ in size, colour and appearance to those shown. If you require further information or customisation, please contact us directly.



Material Conduit fitting	polyamide UL94-V0
Material sealing gasket	TPU
Protection class	IP68
Temp. range min	-40 °C
Temp. range max	100 °C
NW	29
Ø closure VD	47,3 mm
Key width SW1	41 mm
Key width SW2	44 mm
Total length TL	98 mm
Product Color	RAL 9005
Type	BFC-29-29-BK
Order no. RAL 9005	10109730
Packing unit	2
EAN number	4007686264678
Tariff number	39269097
ETIM-Classification	EC001176

23.05.2026

Your Contact:

WISKA Hoppmann GmbH

Kisdorfer Weg 28 · 24568 Kaltenkirchen · Germany

☎ +49-4191-508-0 · 📠 +49-4191-508-209

contact@wiska.de · www.wiska.com

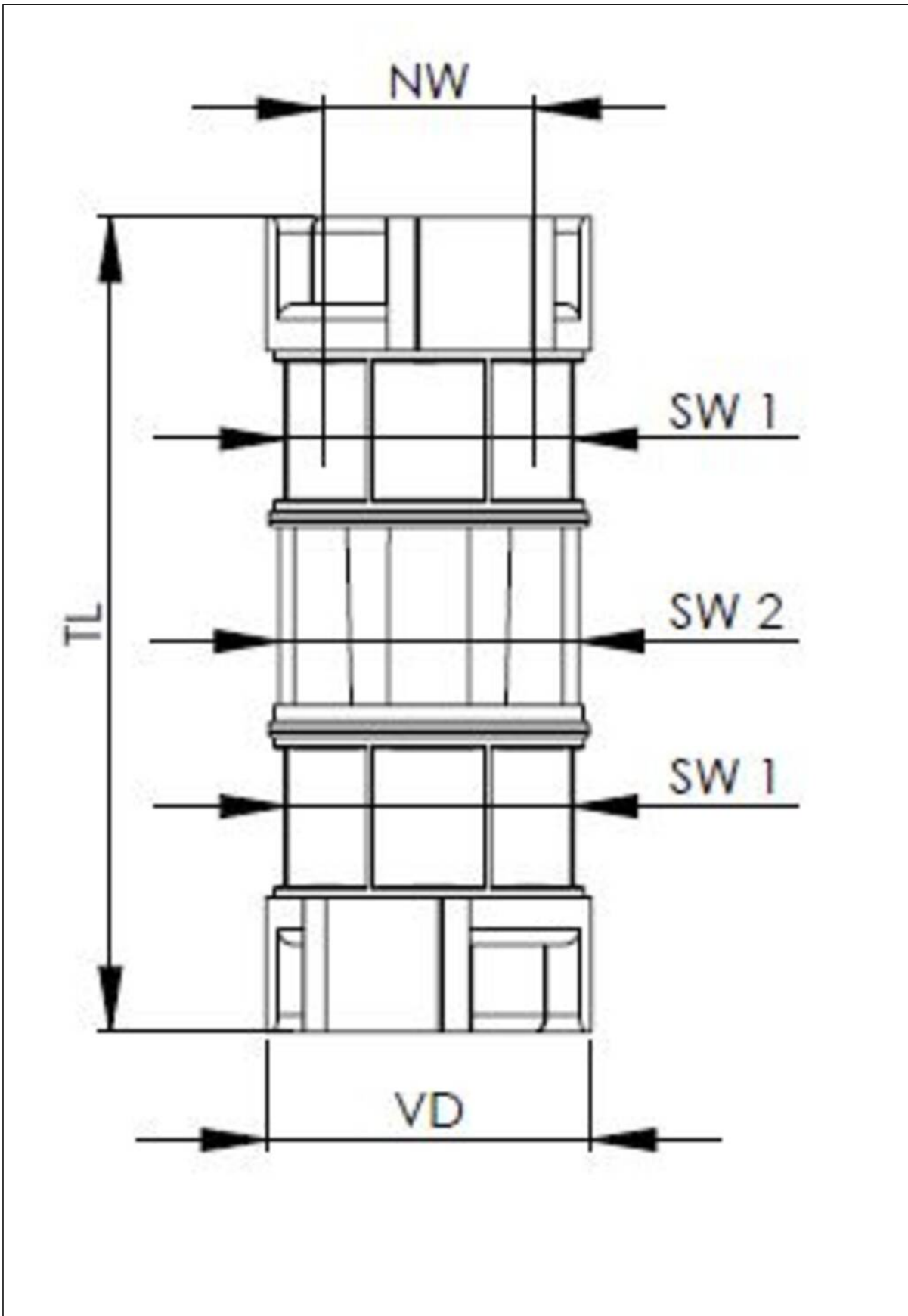

Your Contact:

WISKA Hoppmann GmbH

Kisdorfer Weg 28 · 24568 Kaltenkirchen · Germany

☎ +49-4191-508-0 · 📠 +49-4191-508-209

contact@wiska.de · www.wiska.com