

EBFSI-23-32-BK

Adaptor-Internal Thread, polyamide, RAL 9005, NW 23-M32

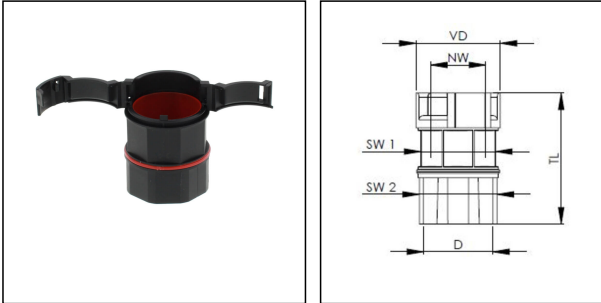

Products may differ in size, colour and appearance to those shown. If you require further information or customisation, please contact us directly.



Material Conduit fitting	polyamide UL94-V0
Material Connection thread	polyamide UL94-V0
Material sealing gasket	TPU
Protection class	IP68
Temp. range min	-40 °C
Temp. range max	100 °C
NW	23
Thread type	M
Ø Connection thread D	32
Lead	1,5
Length screw-in thread L	14,5 mm
Ø closure VD	42,3 mm
Key width SW1	36 mm
Key width SW2	36 mm
Total length TL	56,3 mm
Product Color	RAL 9005
Type	EBFSI-23-32-BK
Order no. RAL 9005	10109743
Packing unit	25
EAN number	4007686264906
Tariff number	39269097
ETIM-Classification	EC001176

23.05.2026

Your Contact:

WISKA Hoppmann GmbH

Kisdorfer Weg 28 · 24568 Kaltenkirchen · Germany

☎ +49-4191-508-0 · 📠 +49-4191-508-209

contact@wiska.de · www.wiska.com

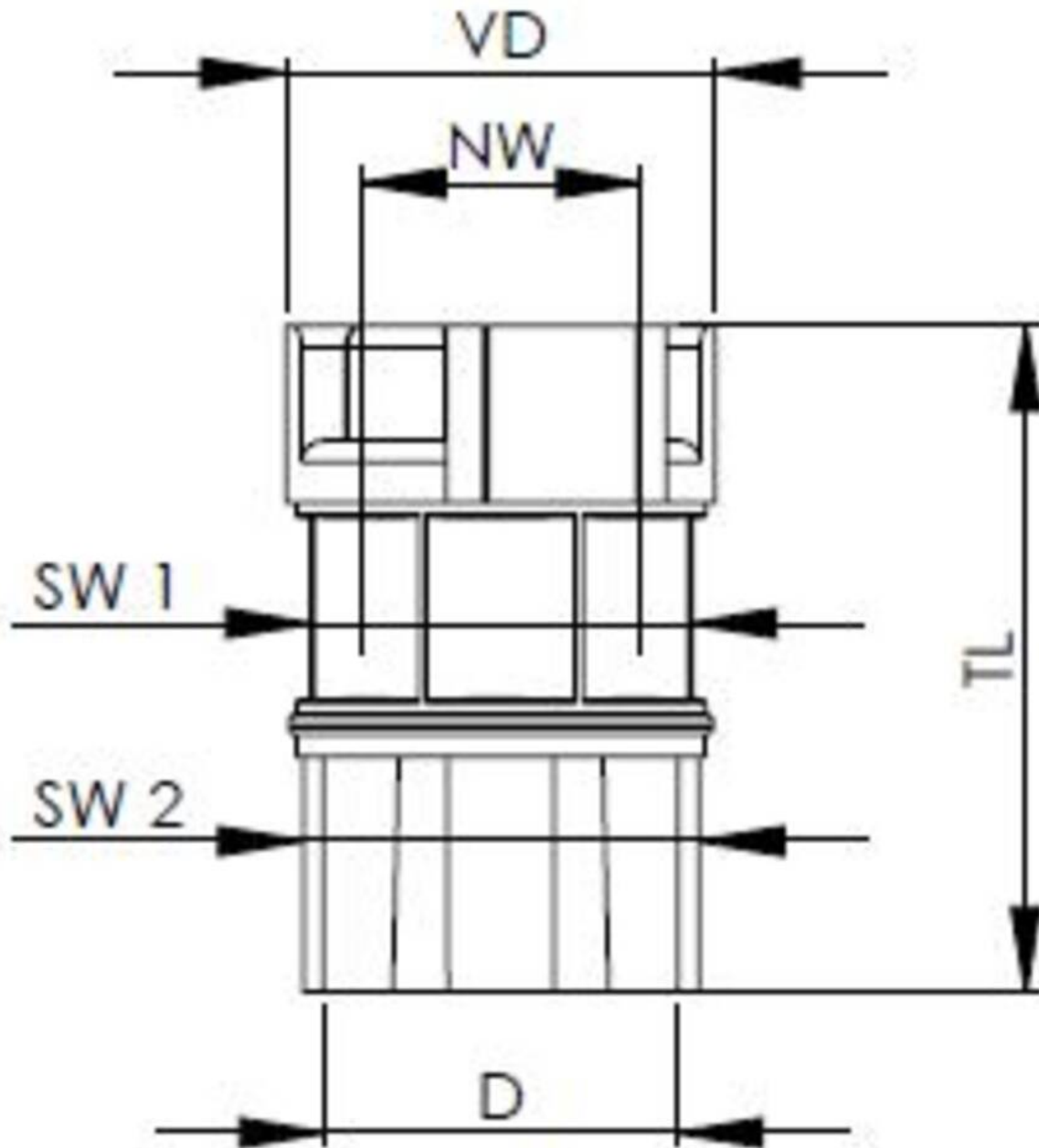

Your Contact:

WISKA Hoppmann GmbH

Kisdorfer Weg 28 · 24568 Kaltenkirchen · Germany

☎ +49-4191-508-0 · 📠 +49-4191-508-209

contact@wiska.de · www.wiska.com