

## EBFSI-17-25-BG

Adaptor-Internal Thread, polyamide, RAL 7031, NW 17-M25

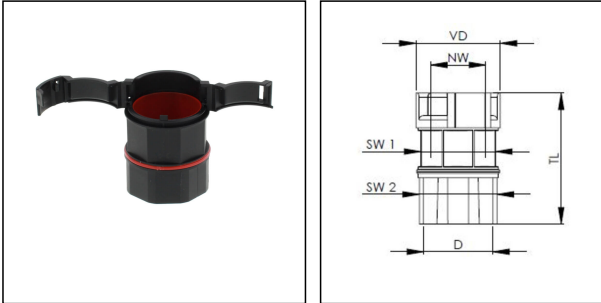

Products may differ in size, colour and appearance to those shown. If you require further information or customisation, please contact us directly.



<b>Material Conduit fitting</b>	polyamide UL94-V0
<b>Material Connection thread</b>	polyamide UL94-V0
<b>Material sealing gasket</b>	TPU
<b>Protection class</b>	IP68
<b>Temp. range min</b>	-40 °C
<b>Temp. range max</b>	100 °C
<b>NW</b>	17
<b>Thread type</b>	M
<b>Ø Connection thread D</b>	25
<b>Lead</b>	1,5
<b>Length screw-in thread L</b>	12,5 mm
<b>Ø closure VD</b>	33,2 mm
<b>Key width SW1</b>	27 mm
<b>Key width SW2</b>	28 mm
<b>Total length TL</b>	47,5 mm
<b>Product Color</b>	RAL 7031
<b>Type</b>	EBFSI-17-25-BG
<b>Order no. RAL 7031</b>	10109749
<b>Packing unit</b>	50
<b>EAN number</b>	4007686264883
<b>Tariff number</b>	39269097
<b>ETIM-Classification</b>	EC001176

23.05.2026

Your Contact:

**WISKA Hoppmann GmbH**

Kisdorfer Weg 28 · 24568 Kaltenkirchen · Germany

☎ +49-4191-508-0 · 📠 +49-4191-508-209

contact@wiska.de · www.wiska.com

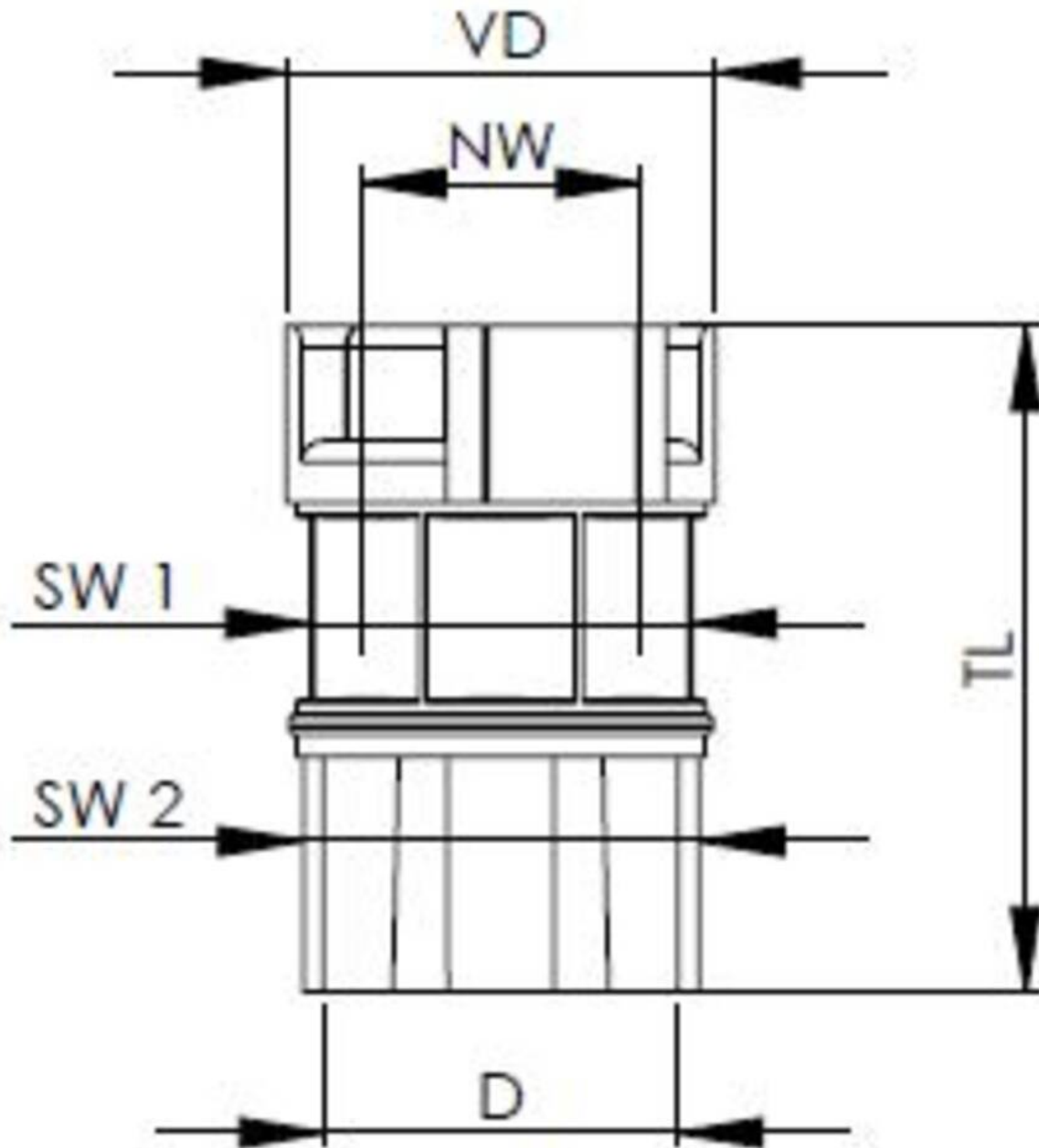

Your Contact:

**WISKA Hoppmann GmbH**

Kisdorfer Weg 28 · 24568 Kaltenkirchen · Germany

☎ +49-4191-508-0 · 📠 +49-4191-508-209

contact@wiska.de · www.wiska.com