

EBFSI-36-50-BG

Adaptor-Internal Thread, polyamide, RAL 7031, NW 36-M50

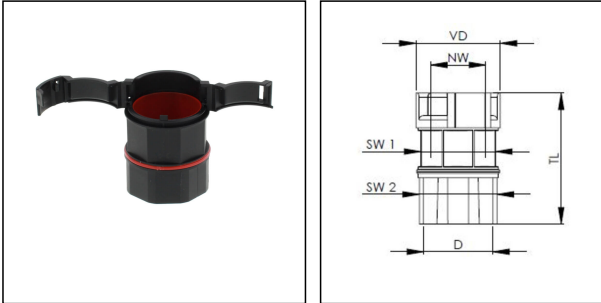

Products may differ in size, colour and appearance to those shown. If you require further information or customisation, please contact us directly.



Material Conduit fitting	polyamide UL94-V0
Material Connection thread	polyamide UL94-V0
Material sealing gasket	TPU
Protection class	IP68
Temp. range min	-40 °C
Temp. range max	100 °C
NW	36
Thread type	M
Ø Connection thread D	50
Lead	1,5
Length screw-in thread L	15,5 mm
Ø closure VD	55,7 mm
Key width SW1	50 mm
Key width SW2	54 mm
Total length TL	60,3 mm
Product Color	RAL 7031
Type	EBFSI-36-50-BG
Order no. RAL 7031	10109752
Packing unit	10
EAN number	4007686265002
Tariff number	39269097
ETIM-Classification	EC001176

23.05.2026

Your Contact:

WISKA Hoppmann GmbH

Kisdorfer Weg 28 · 24568 Kaltenkirchen · Germany

☎ +49-4191-508-0 · 📠 +49-4191-508-209

contact@wiska.de · www.wiska.com

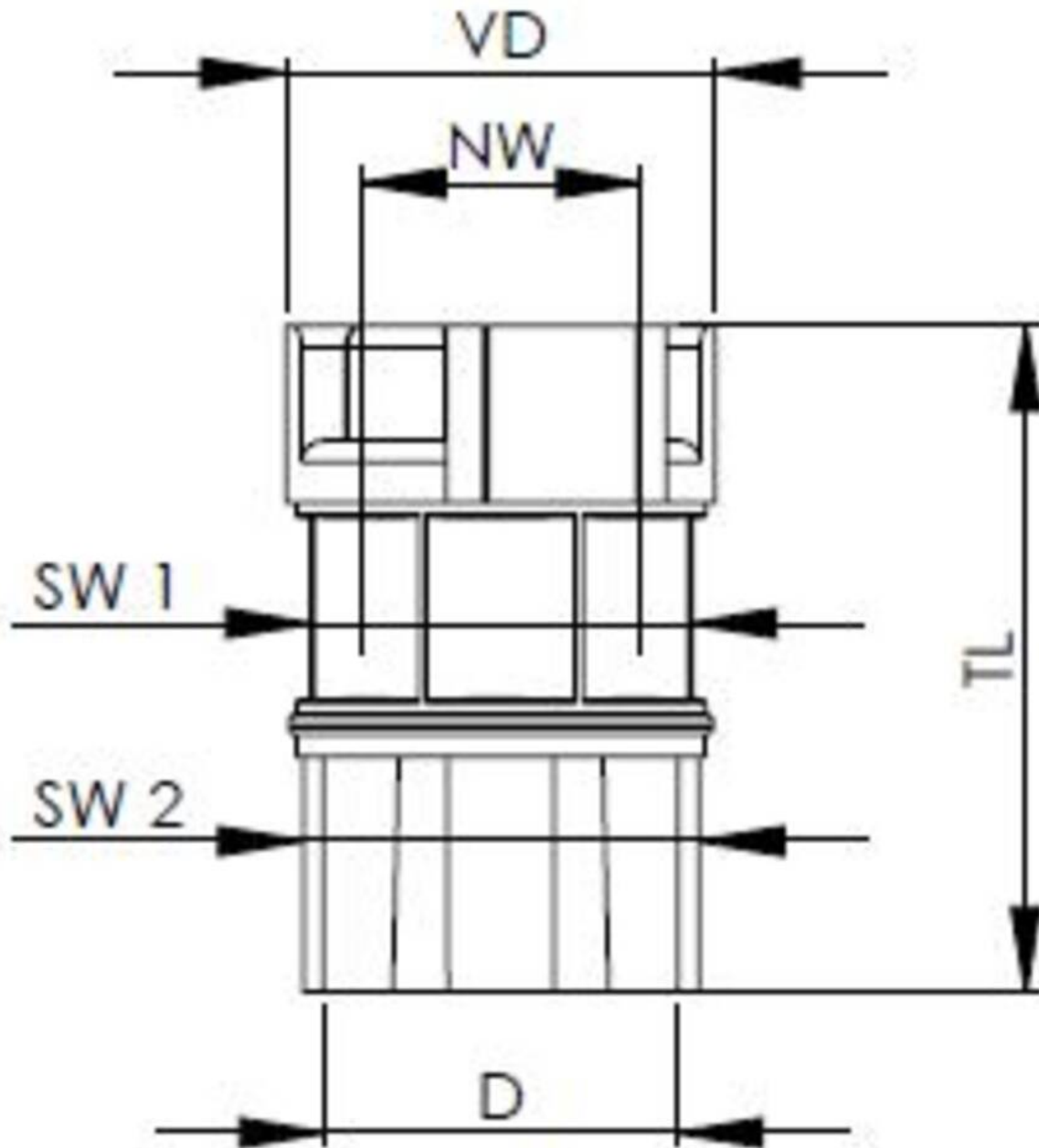

Your Contact:

WISKA Hoppmann GmbH

Kisdorfer Weg 28 · 24568 Kaltenkirchen · Germany

☎ +49-4191-508-0 · 📠 +49-4191-508-209

contact@wiska.de · www.wiska.com