

EBFSI-48-63-BG

Adaptor-Internal Thread, polyamide, RAL 7031, NW 48-M63

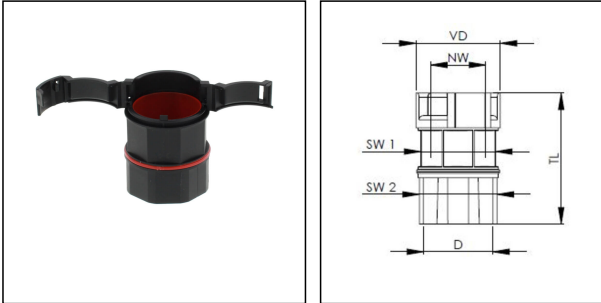

Products may differ in size, colour and appearance to those shown. If you require further information or customisation, please contact us directly.



Material Conduit fitting	polyamide UL94-V0
Material Connection thread	polyamide UL94-V0
Material sealing gasket	TPU
Protection class	IP68
Temp. range min	-40 °C
Temp. range max	100 °C
NW	48
Thread type	M
Ø Connection thread D	63
Lead	1,5
Length screw-in thread L	16,5 mm
Ø closure VD	68,1 mm
Key width SW1	60 mm
Key width SW2	67 mm
Total length TL	62,8 mm
Product Color	RAL 7031
Type	EBFSI-48-63-BG
Order no. RAL 7031	10109753
Packing unit	5
EAN number	4007686265040
Tariff number	39269097
ETIM-Classification	EC001176

23.05.2026

Your Contact:

WISKA Hoppmann GmbH

Kisdorfer Weg 28 · 24568 Kaltenkirchen · Germany

☎ +49-4191-508-0 · 📠 +49-4191-508-209

contact@wiska.de · www.wiska.com

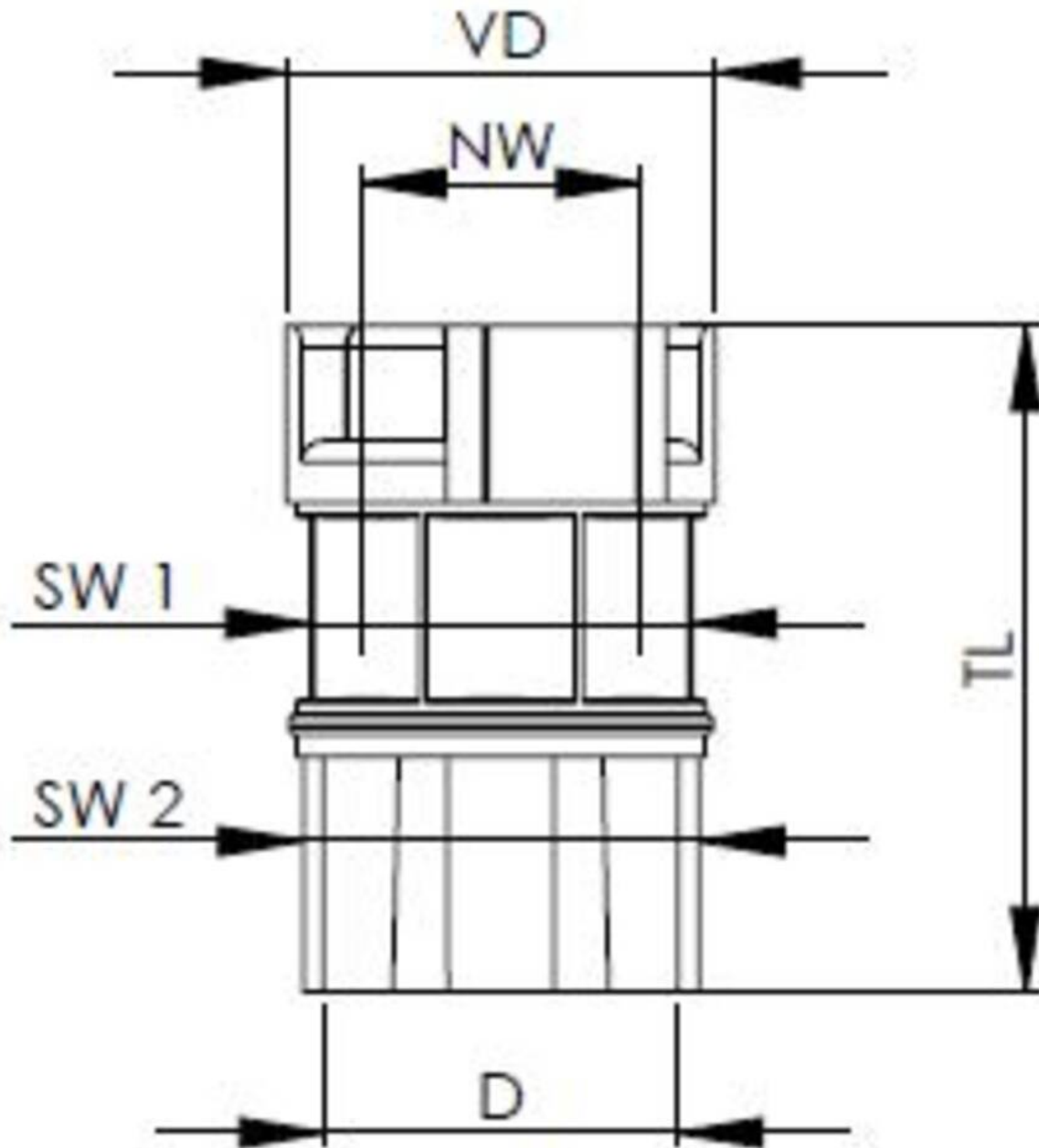

Your Contact:

WISKA Hoppmann GmbH

Kisdorfer Weg 28 · 24568 Kaltenkirchen · Germany

☎ +49-4191-508-0 · 📠 +49-4191-508-209

contact@wiska.de · www.wiska.com