

EMSKE 20 MFD 02/060

Ex-cable gland, brass nickel-plated with mounted multiple sealing insert, M20

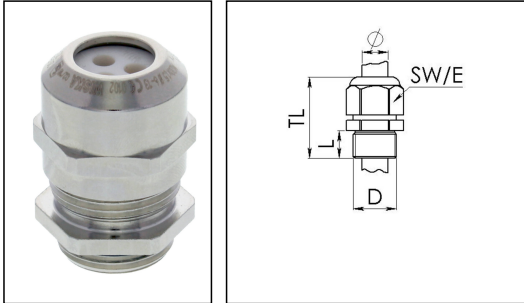

Products may differ in size, colour and appearance to those shown. If you require further information or customisation, please contact us directly.



Material cable gland	Brass nickel-plated
Material clamping cage	Polyamide
Material sealing gasket	EPDM
Temp. range min	-40 °C
Temp. range max	75 °C
Protection class	IP66 / IP68 (5 bar 30 min)
Type of protection	Ex eb, Ex tb
Ex-Certificate	ATEX, IECEx
Thread type	M
Ø Connection thread D	20
Lead	1,5
Length screw-in thread L	6 mm
Ø cable diameter min	5,4 mm
Ø cable diameter max	6 mm
Number of cable entries	2
Key width SW	24 mm
Collar diameter (E)	27 mm
Total length TL	29 mm - 37 mm
Install. torques fitting	8 N m
Install. torques cap nut	8 N m
Surface	Nickel-plated
Order no. nickel-plated	10110038
Type	EMSKE 20 MFD 02/060
Packing unit	50
Tariff number	74198090

Your Contact:

WISKA Hoppmann GmbH

Kisdorfer Weg 28 · 24568 Kaltenkirchen · Germany

☎ +49-4191-508-0 · 📠 +49-4191-508-209

contact@wiska.de · www.wiska.com

EAN number	4007686114300
ETIM-Classification	EC000441

Recommended accessories

EMMU 20	10063143
----------------	----------

12.05.2026

Your Contact:

WISKA Hoppmann GmbH

Kisdorfer Weg 28 · 24568 Kaltenkirchen · Germany

 +49-4191-508-0 ·  +49-4191-508-209

contact@wiska.de · www.wiska.com



Your Contact:

WISKA Hoppmann GmbH

Kisdorfer Weg 28 · 24568 Kaltenkirchen · Germany

☎ +49-4191-508-0 · 📠 +49-4191-508-209

contact@wiska.de · www.wiska.com