

ESKE/1-i 32 MFD 06/060

Ex Cable gland, plastic, RAL 9005/5012, M32, with mounted MFD

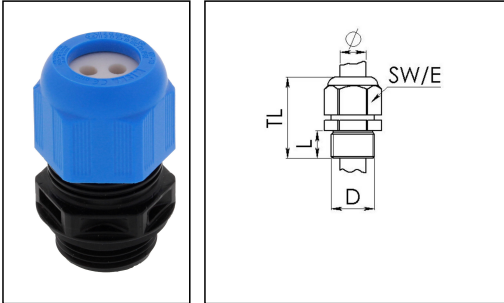

Products may differ in size, colour and appearance to those shown. If you require further information or customisation, please contact us directly.



Material cable gland	Polyamide
Material sealing gasket	EPDM, TPE
Temp. range min	-40 °C
Temp. range max	75 °C
Protection class	IP66 / IP68 (5 bar 30 min)
Type of protection	Ex eb, Ex tb
Ex-Certificate	ATEX, IECEx
Glow wire test	750 °C
Thread type	M
Ø Connection thread D	32
Lead	1,5
Length screw-in thread L	12 mm
Ø cable diameter min	5,4 mm
Ø cable diameter max	6 mm
Number of cable entries	6
Key width SW	36 mm
Collar diameter (E)	40 mm
Total length TL	42 mm - 51 mm
Install. torques fitting	4,5 N m
Install. torques cap nut	3 N m
Equipment	Incl. connection thread gasket
Product Color	RAL 5012 / RAL 9005
Order no. RAL 9005	10110268
Type	ESKE/1-i 32 MFD 06/060
Packing unit	25

Your Contact:

WISKA Hoppmann GmbH

Kisdorfer Weg 28 · 24568 Kaltenkirchen · Germany

☎ +49-4191-508-0 · 📠 +49-4191-508-209

contact@wiska.de · www.wiska.com

EAN number	4007686169829
Tariff number	39269097
ETIM-Classification	EC000441

12.05.2026

Your Contact:

WISKA Hoppmann GmbH

Kisdorfer Weg 28 · 24568 Kaltenkirchen · Germany

☎ +49-4191-508-0 · 📠 +49-4191-508-209

contact@wiska.de · www.wiska.com

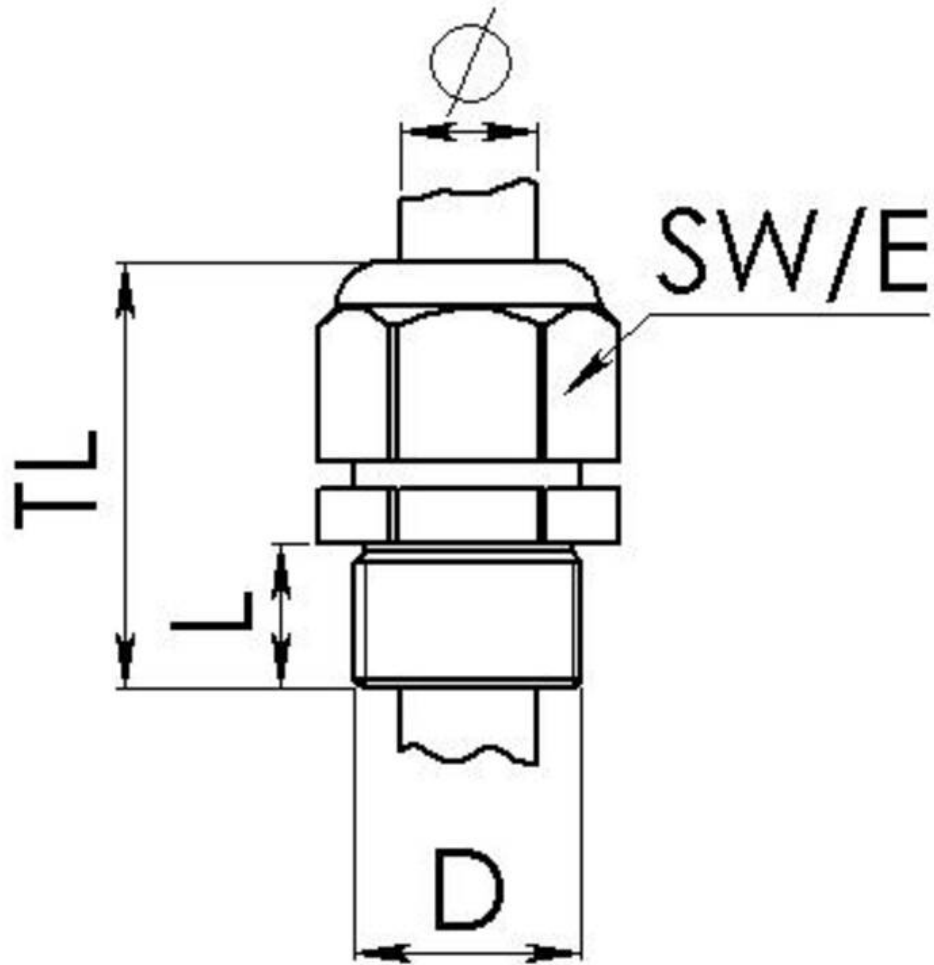

Your Contact:

WISKA Hoppmann GmbH

Kisdorfer Weg 28 · 24568 Kaltenkirchen · Germany

☎ +49-4191-508-0 · 📠 +49-4191-508-209

contact@wiska.de · www.wiska.com