

VARITAIN® Advance/04/03/M50/25kA/LED/TW

Reefer container socket 32A 25kA 440V 3h 4-gang, stainless steel, RAL 9016

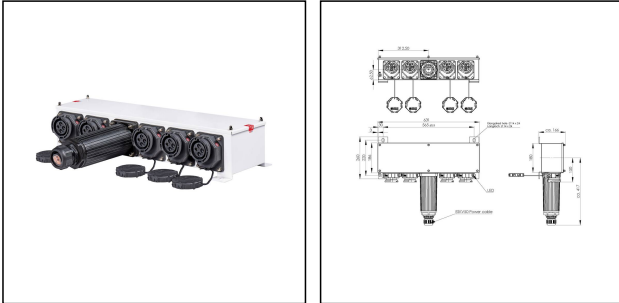

Products may differ in size, colour and appearance to those shown. If you require further information or customisation, please contact us directly.



WISKA-Order no.	10110291
Type	VARITAIN® Advance/04/03/M50/25kA/LED/TW
Material	Stainless steel 1.4301 (V2A)
Material protective cap	Polyamide
Socket insert	3 - poles + PE
Clock face position	3h
Number of sockets	4
Breaking capacity	25 kA
Voltage max. (V)	440 V
Type of Voltage	AC
Current	32 A
Protection class	IP66 / IP67
Operational areas	Outdoor
Temp. range min	-25 °C
Temp. range max	45 °C
Type of cable gland	M 50 x 1,5
Mounting	Wall, Surface mounting
Colour	RAL 9016
Approval	DNV-GL
Variations	on request
Tariff number	85366990

Spare parts

Your Contact:

WISKA Hoppmann GmbH

Kisdorfer Weg 28 · 24568 Kaltenkirchen · Germany

☎ +49-4191-508-0 · 📠 +49-4191-508-209

contact@wiska.de · www.wiska.com

SP-CAP NUTS M6	22000402
SP-BC/FS-CEE/BELT/32A	22000403
SP-VARI-PI/SM/LED/25kA/NUTS	22000427
SP-VENTPLUG 12	22000430
SP-LID GASKET	22000431
SP-VARI-PI/LED/25kA/BC/NUTS	22000606
SP-VARI/TB 35mm²	22000615
SP-VARI-PI/LED CIRCUIT BOARD	22000908

07.07.2026

Your Contact:

WISKA Hoppmann GmbH

Kisdorfer Weg 28 · 24568 Kaltenkirchen · Germany

☎ +49-4191-508-0 · 📠 +49-4191-508-209

contact@wiska.de · www.wiska.com

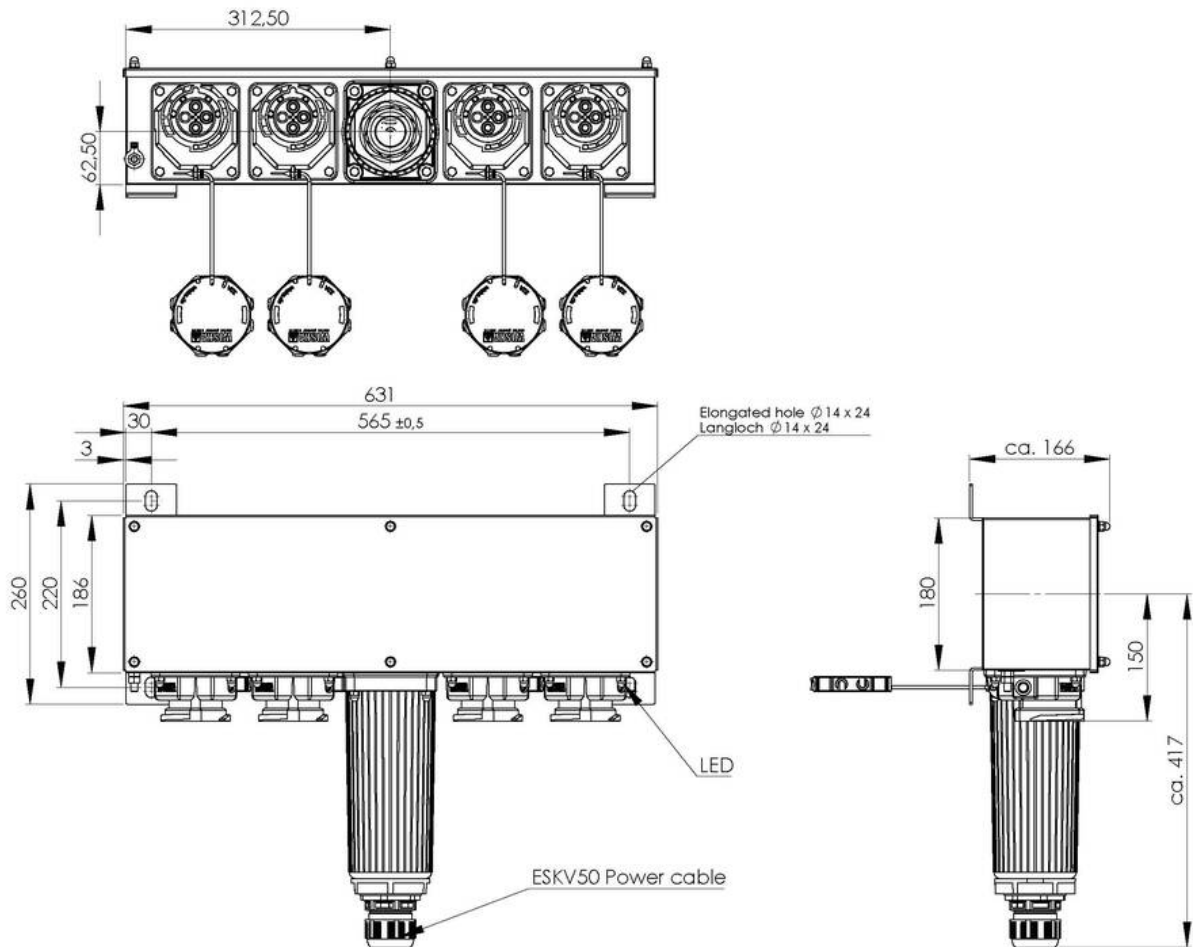

Your Contact:

WISKA Hoppmann GmbH

Kisdorfer Weg 28 · 24568 Kaltenkirchen · Germany

☎ +49-4191-508-0 · 📠 +49-4191-508-209

contact@wiska.de · www.wiska.com