

ZER 11-18 LG

Strain relief ring, PC + ABS-Blend V0, RAL 7035, 11-18mm

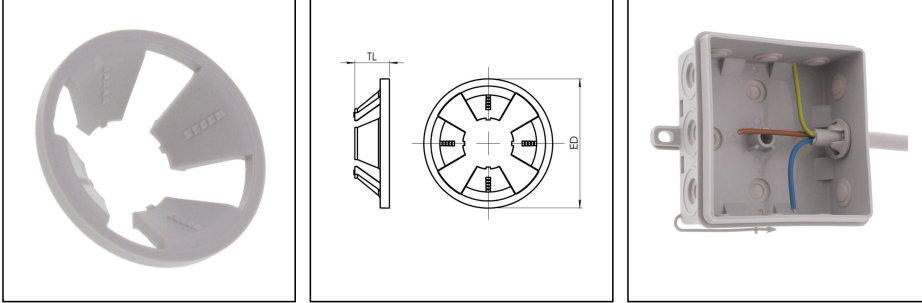

Products may differ in size, colour and appearance to those shown. If you require further information or customisation, please contact us directly.

Material	PC + ABS-Blend V0
Product Color	RAL 7035
Temp. range min	-30 °C
Temp. range max	100 °C
Ø cable diameter min	11 mm
Ø cable diameter max	18 mm
External diameter ED	28 mm
Total length TL	7,5 mm
Type	ZER 11-18 LG
WISKA-Order no.	10110766
Packing unit	10
EAN number	4007686256864
Tariff number	39269097

23.05.2026

Your Contact:

WISKA Hoppmann GmbH

Kisdorfer Weg 28 · 24568 Kaltenkirchen · Germany

☎ +49-4191-508-0 · 📠 +49-4191-508-209

contact@wiska.de · www.wiska.com

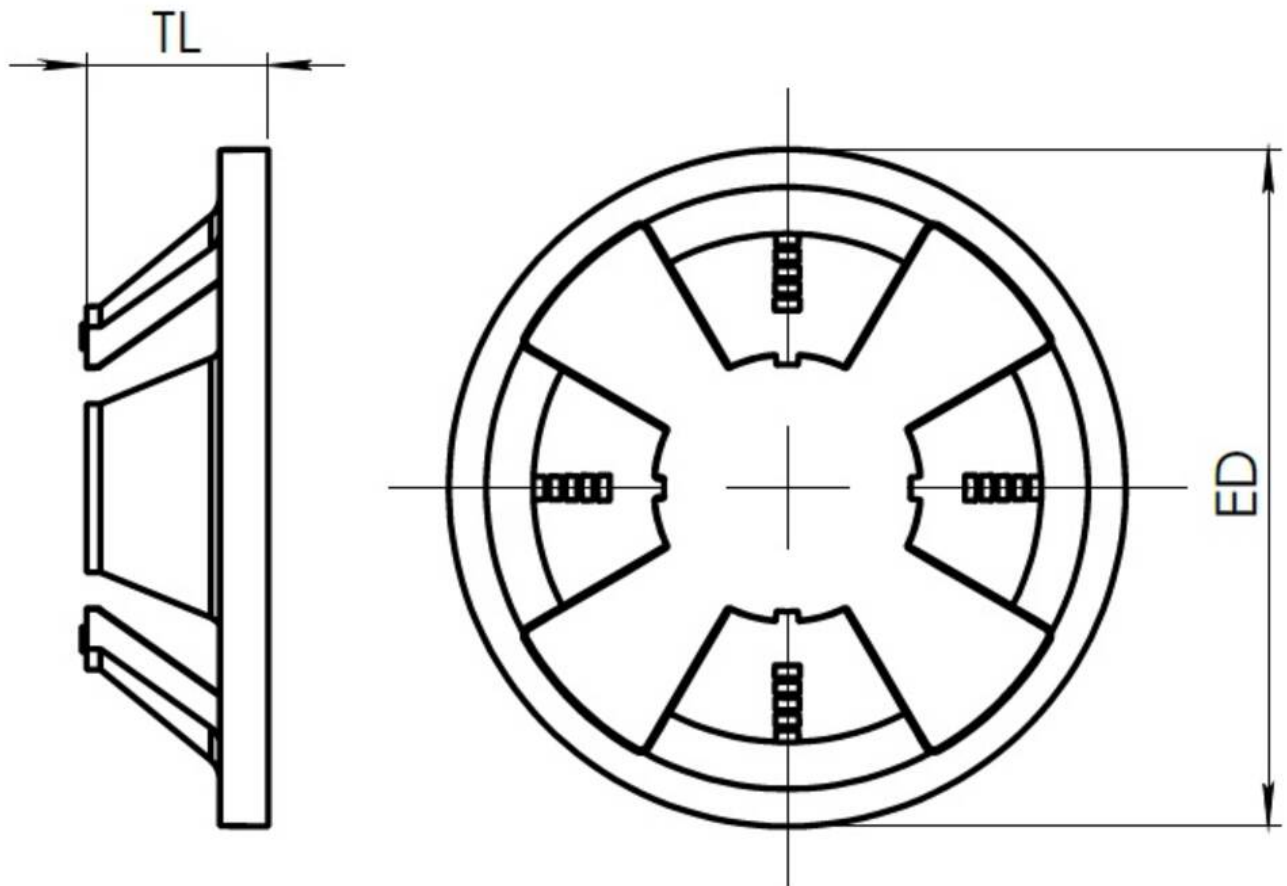

Your Contact:

WISKA Hoppmann GmbH

Kisdorfer Weg 28 · 24568 Kaltenkirchen · Germany

☎ +49-4191-508-0 · 📠 +49-4191-508-209

contact@wiska.de · www.wiska.com