

CO-16A-FS-400V-4P-6H-IP67-K03-C01

CEE coupling 16A 400V 6h, plastic, IP67

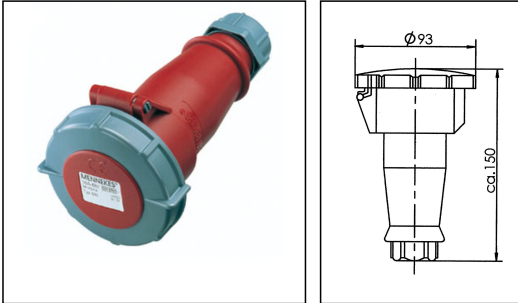

Products may differ in size, colour and appearance to those shown. If you require further information or customisation, please contact us directly.

WISKA-Order no.	50014236
Type	CO-16A-FS-400V-4P-6H-IP67-K03-C01
Material	Plastic
Current	16 A
Voltage max. (V)	400 V
Protection class	IP67
Temp. range min	-25 °C
Temp. range max	45 °C
plug insert	CEE
Clock face position	6h
Terminals/poles	3-pole + E
Ø cable diameter max	16 mm
Weight	0,2 kg
Variations	on request
Tariff number	85366990

Remarks:

Contact: standard

Connection technology: Screw terminals
one-piece housing, gland with seal
gasket, bend protection and strain relief

12.05.2026

Your Contact:

WISKA Hoppmann GmbH
Kisdorfer Weg 28 · 24568 Kaltenkirchen · Germany
☎ +49-4191-508-0 · 📠 +49-4191-508-209
contact@wiska.de · www.wiska.com

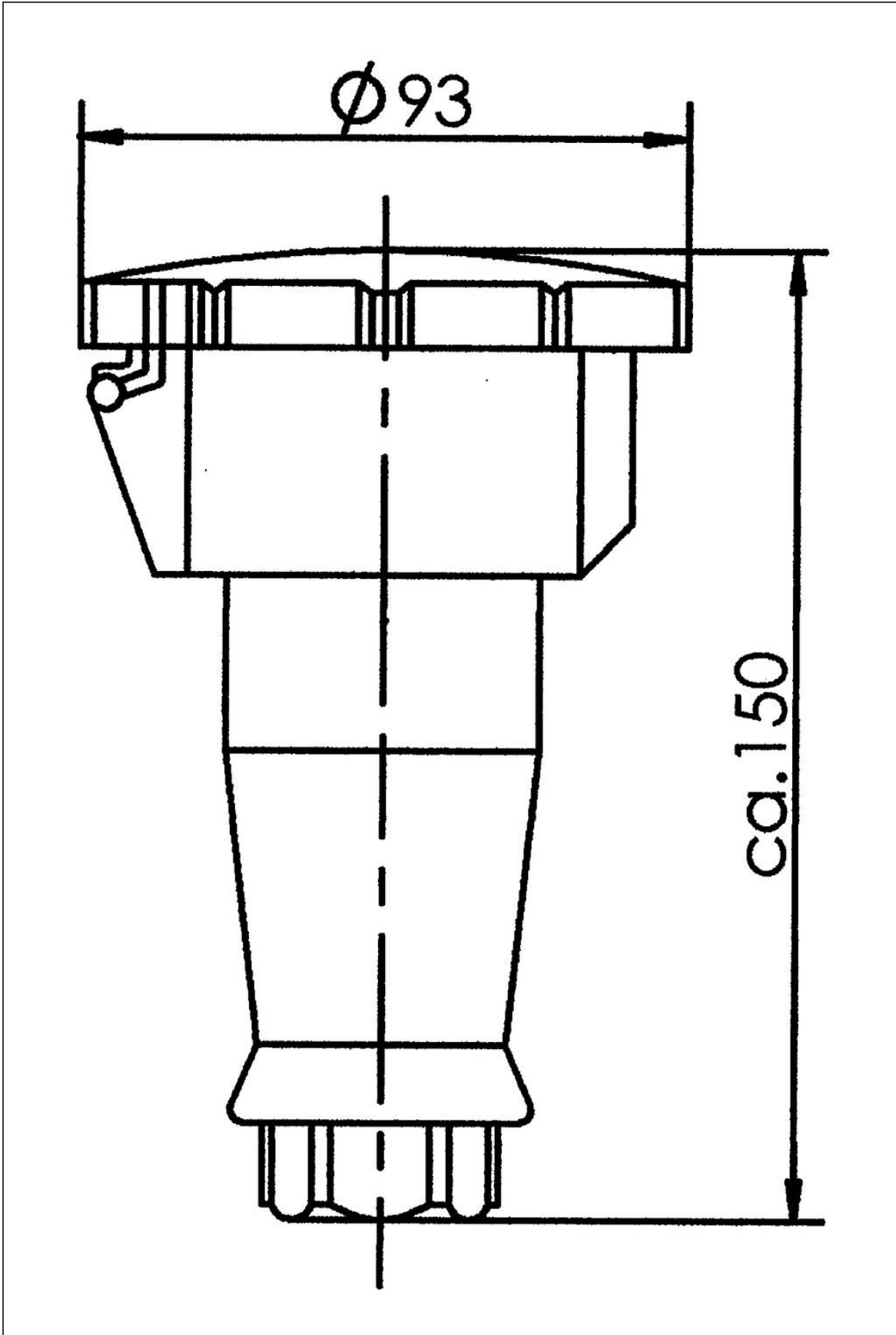

Your Contact:

WISKA Hoppmann GmbH

Kisdorfer Weg 28 · 24568 Kaltenkirchen · Germany

☎ +49-4191-508-0 · 📠 +49-4191-508-209

contact@wiska.de · www.wiska.com