

FD 50 SG

FLIP cable grommet, EPDM, RAL 7001, M50

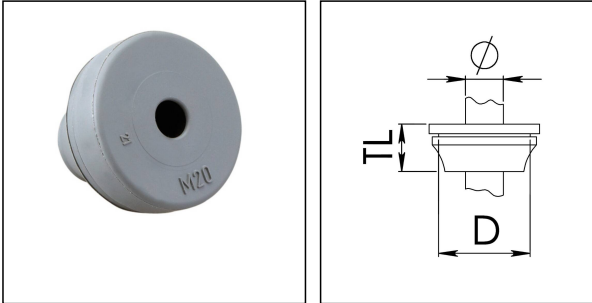

Products may differ in size, colour and appearance to those shown. If you require further information or customisation, please contact us directly.



Material	EPDM
Temp. range min	-40 °C
Temp. range max	110 °C
Protection class	IP66 / IP67
Thread type	M
Ø Connection thread D	50
Ø cable diameter min	27 mm
Ø cable diameter max	35 mm
Total length TL	35 mm
Ø Drilling	50 mm - 51 mm
Wall thickness S	1 mm - 4 mm
Product Color	RAL 7001
Order no. RAL 7001	50062776
Type	FD 50 SG
Packing unit	10
EAN number	4007685627764
Tariff number	40169300
ETIM-Classification	EC000451

26.06.2026

Your Contact:

WISKA Hoppmann GmbH

Kisdorfer Weg 28 · 24568 Kaltenkirchen · Germany

☎ +49-4191-508-0 · 📠 +49-4191-508-209

contact@wiska.de · www.wiska.com

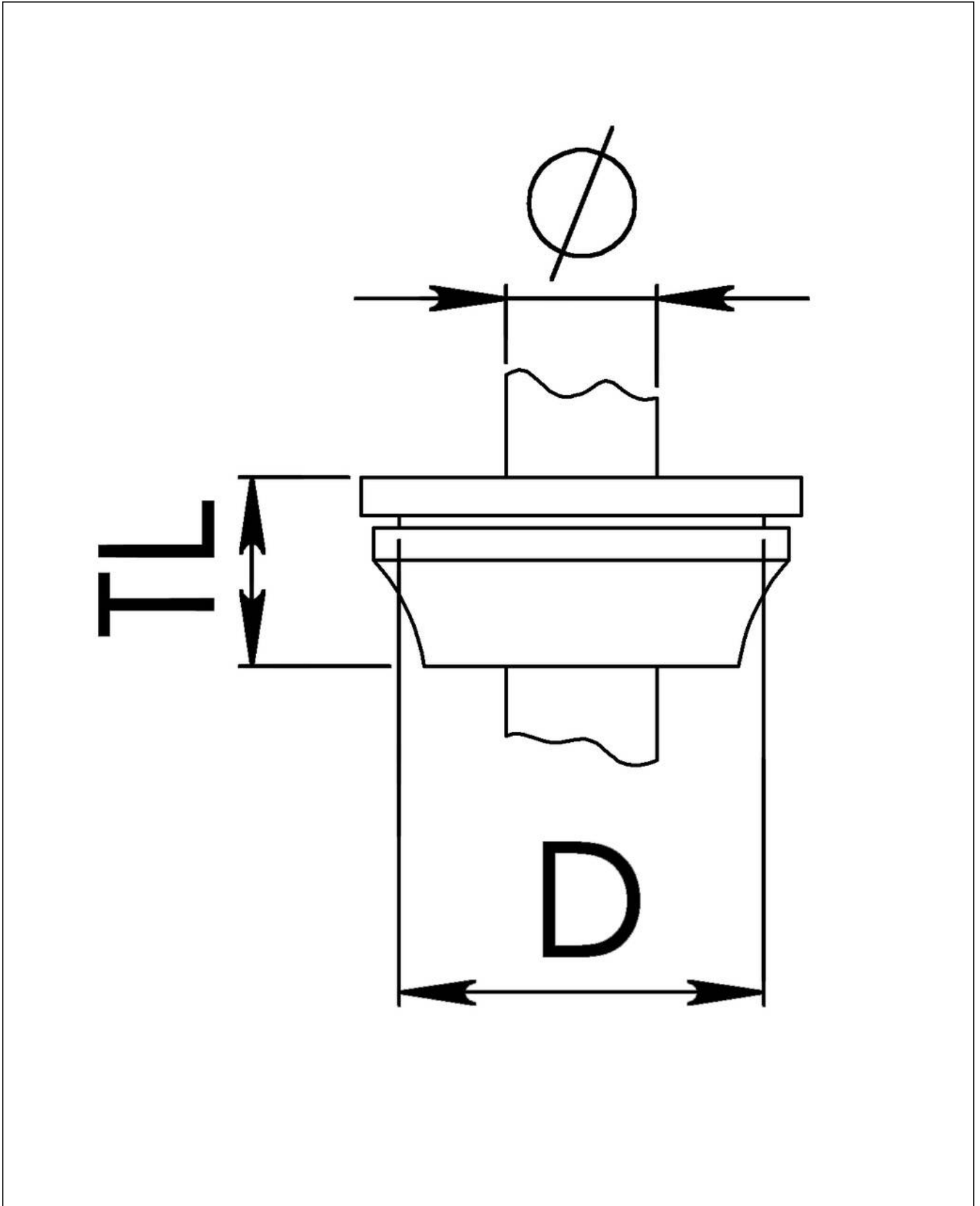

Your Contact:

WISKA Hoppmann GmbH

Kisdorfer Weg 28 · 24568 Kaltenkirchen · Germany

☎ +49-4191-508-0 · 📠 +49-4191-508-209

contact@wiska.de · www.wiska.com