

## FD 32 BK

FLIP cable grommet, EPDM, RAL 9005, M32

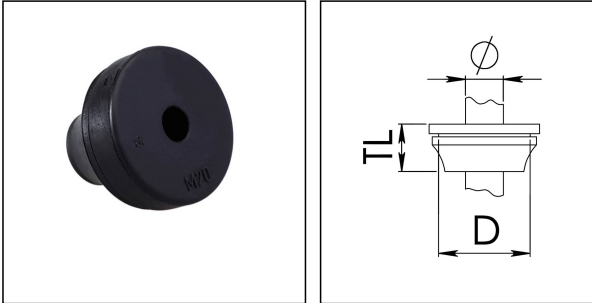

Products may differ in size, colour and appearance to those shown. If you require further information or customisation, please contact us directly.



<b>Material</b>	EPDM
<b>Temp. range min</b>	-40 °C
<b>Temp. range max</b>	110 °C
<b>Protection class</b>	IP66 / IP67
<b>Thread type</b>	M
<b>Ø Connection thread D</b>	32
<b>Ø cable diameter min</b>	15 mm
<b>Ø cable diameter max</b>	20 mm
<b>Total length TL</b>	25 mm
<b>Ø Drilling</b>	32 mm - 33 mm
<b>Wall thickness S</b>	1 mm - 4 mm
<b>Product Color</b>	RAL 9005
<b>Order no. RAL 9005</b>	50062895
<b>Type</b>	FD 32 BK
<b>Packing unit</b>	25
<b>EAN number</b>	4007685628952
<b>Tariff number</b>	39269097
<b>ETIM-Classification</b>	EC000451

26.06.2026

Your Contact:

**WISKA Hoppmann GmbH**

Kisdorfer Weg 28 · 24568 Kaltenkirchen · Germany

☎ +49-4191-508-0 · 📠 +49-4191-508-209

contact@wiska.de · www.wiska.com

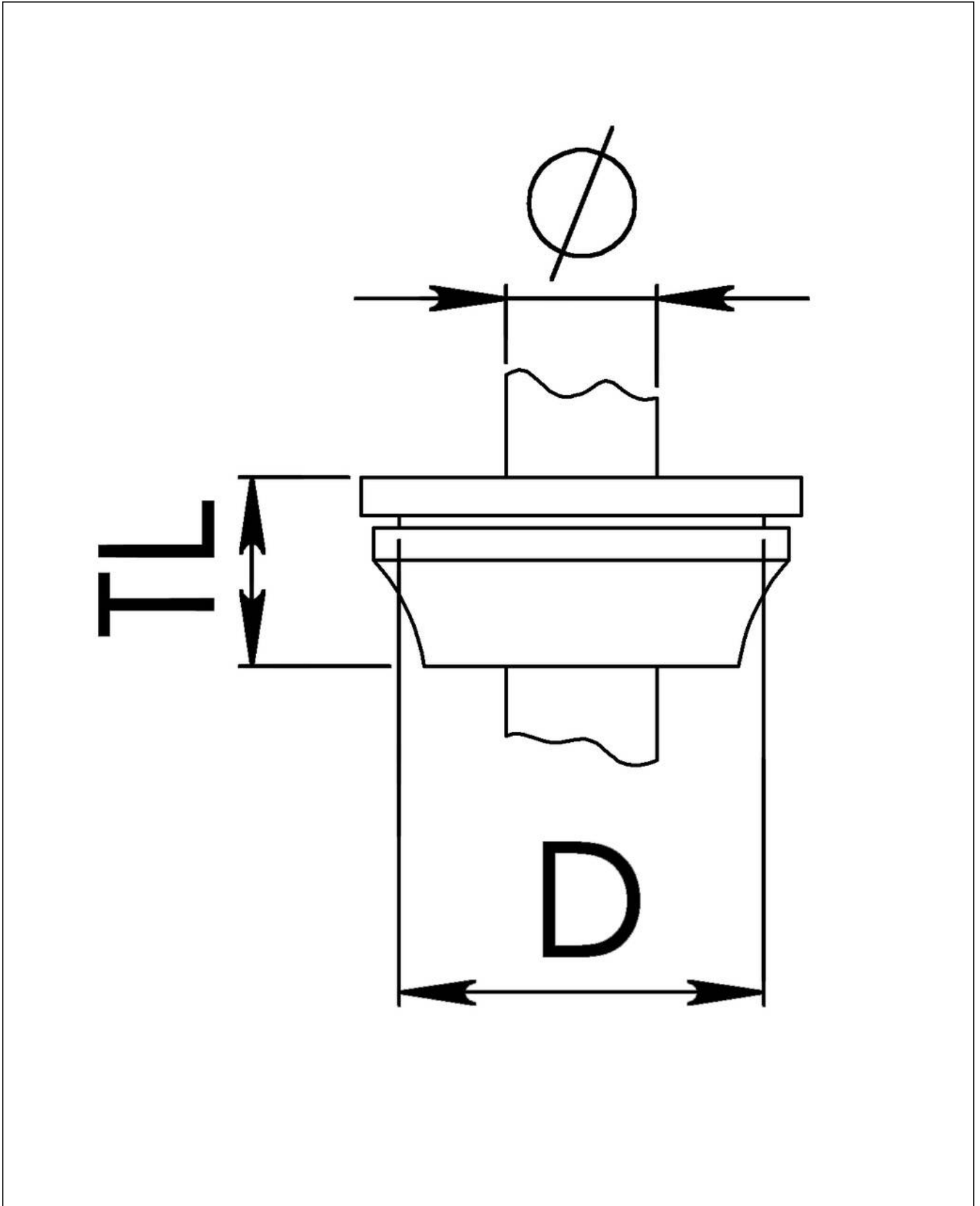

Your Contact:

**WISKA Hoppmann GmbH**

Kisdorfer Weg 28 · 24568 Kaltenkirchen · Germany

☎ +49-4191-508-0 · 📠 +49-4191-508-209

contact@wiska.de · www.wiska.com