

OSAJ 25 / M20(M)*M25(F)

Ex d enlargement adaptor, brass nickel-plated, M20-M25

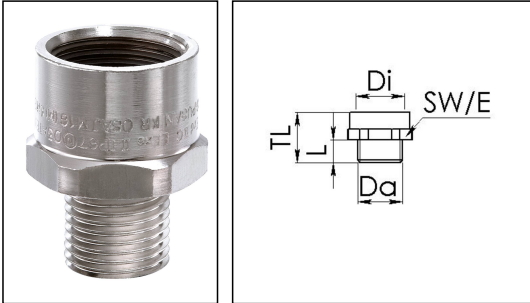

Products may differ in size, colour and appearance to those shown. If you require further information or customisation, please contact us directly.



Material	Brass nickel-plated
Temp. range min	-60 °C
Temp. range max	110 °C
Protection class	IP66 / IP67
Type of protection	Ex eb, Ex db, Ex tb
Ex-Certificate	IECEx, ATEX
Thread type outer	M
Ø outer thread	20
Lead outer	1,5
Thread type inner	M
Ø inner thread	25
Lead inner	1,5
Length screw-in thread L	15 mm
Key width SW	31 mm
Collar diameter (E)	34 mm
Total length TL	36 mm
Surface	Nickel-plated
Order no. nickel-plated	50065688
Type	OSAJ 25 / M20(M)*M25(F)
Packing unit	1
Tariff number	74198090
EAN number	4007685656887
ETIM-Classification	EC000938

Your Contact:

WISKA Hoppmann GmbH

Kisdorfer Weg 28 · 24568 Kaltenkirchen · Germany

☎ +49-4191-508-0 · 📠 +49-4191-508-209

contact@wiska.de · www.wiska.com

23.05.2026

Your Contact:

WISKA Hoppmann GmbH

Kisdorfer Weg 28 · 24568 Kaltenkirchen · Germany

☎ +49-4191-508-0 · 📠 +49-4191-508-209

contact@wiska.de · www.wiska.com



Your Contact:

WISKA Hoppmann GmbH

Kisdorfer Weg 28 · 24568 Kaltenkirchen · Germany

☎ +49-4191-508-0 · 📠 +49-4191-508-209

contact@wiska.de · www.wiska.com