

PL-16A-FS-110V-3P-4H-IP67-K03-C01

CEE plug 16A 110V 4h, plastic, IP67

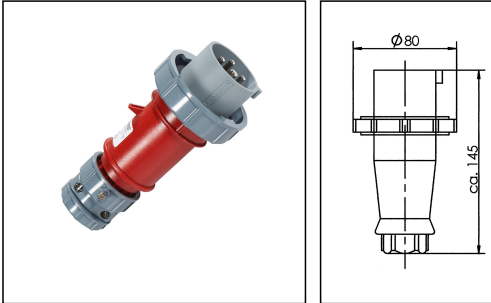

Products may differ in size, colour and appearance to those shown. If you require further information or customisation, please contact us directly.

WISKA-Order no.	50104753
Type	PL-16A-FS-110V-3P-4H-IP67-K03-C01
Material	Plastic
Current	16 A
Voltage max. (V)	110 V
Protection class	IP67
Temp. range min	-25 °C
Temp. range max	45 °C
plug insert	CEE
Clock face position	4h
Terminals/poles	2-pole + E
Ø cable diameter max	14,5 mm
Weight	0,16 kg
Variations	on request
Tariff number	85366990

Remarks:

Contact: standard

Connection technology: Screw terminals

one-piece housing

gland with seal gasket

bend protection and strain relief

12.05.2026

Your Contact:

WISKA Hoppmann GmbH

Kisdorfer Weg 28 · 24568 Kaltenkirchen · Germany

☎ +49-4191-508-0 · 📠 +49-4191-508-209

contact@wiska.de · www.wiska.com

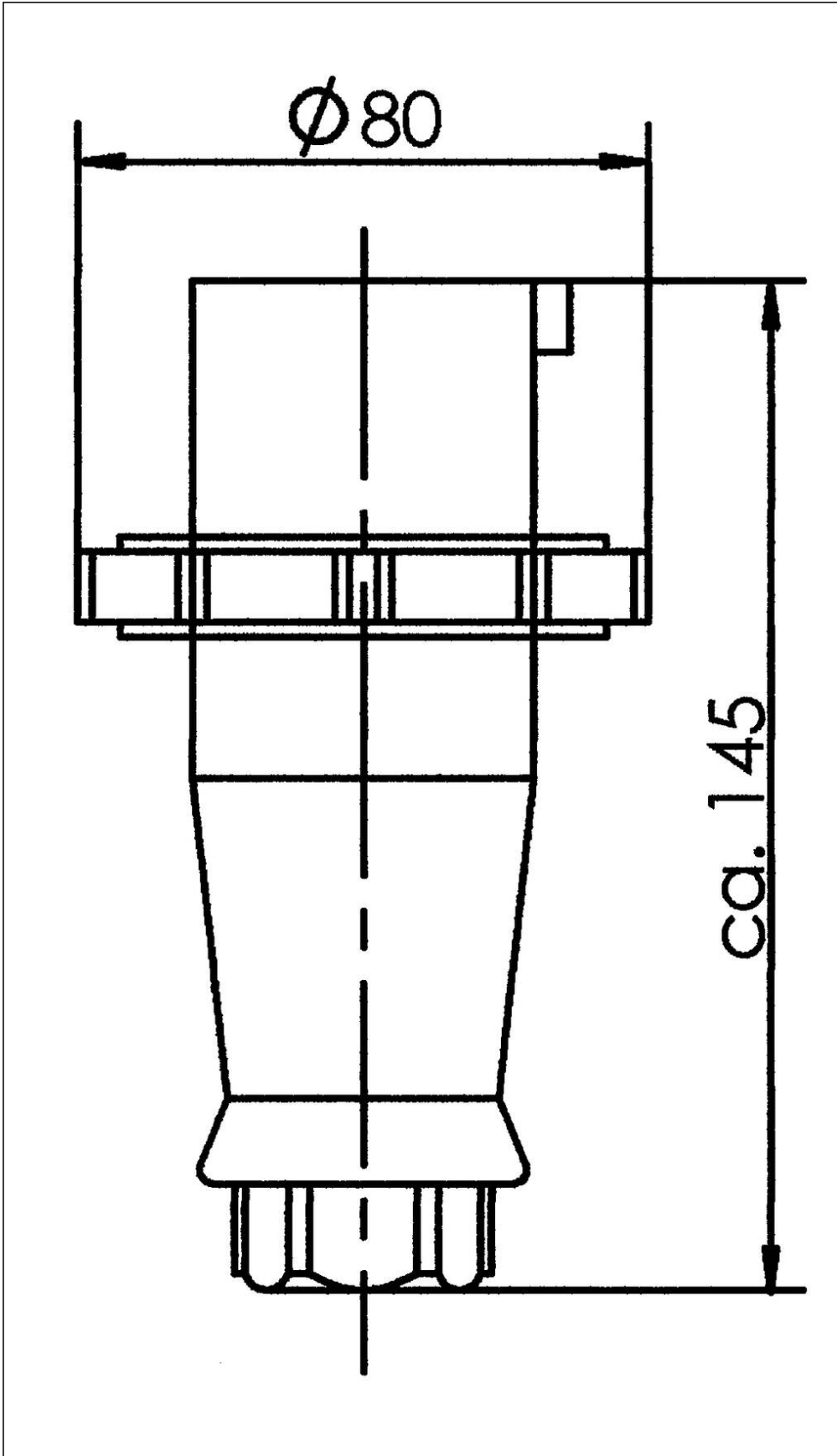

Your Contact:

WISKA Hoppmann GmbH

Kisdorfer Weg 28 · 24568 Kaltenkirchen · Germany

☎ +49-4191-508-0 · 📠 +49-4191-508-209

contact@wiska.de · www.wiska.com