

OS-A2F-U 16 / M16

Ex d cable gland, brass nickel-plated, M16

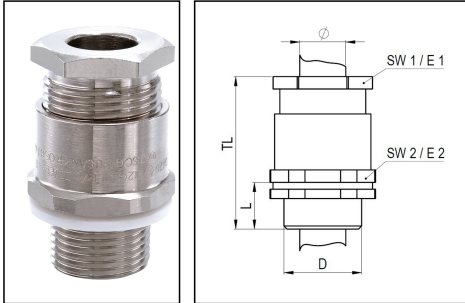

Products may differ in size, colour and appearance to those shown. If you require further information or customisation, please contact us directly.



Material cable gland	Brass nickel-plated
Material sealing gasket	Silicone
Temp. range min	-60 °C
Temp. range max	110 °C
Protection class	IP66 / IP67
Type of protection	Ex tb, Ex eb, Ex db
Ex-Certificate	IECEX, ATEX
Thread type	M
Ø Connection thread D	16
Lead	1,5
Length screw-in thread L	15 mm
Ø cable diameter min	3 mm
Ø cable diameter max	7 mm
Key width SW1	19 mm
Key width SW2	24 mm
Collar diameter E1	22 mm
Collar diameter E2	26 mm
Total length TL	44 mm
Install. torques fitting	20 N m
Install. torques cap nut	5 N m
Equipment	incl. locknut, Incl. connection thread gasket
Surface	Nickel-plated
Order no. nickel-plated	50107568
Type	OS-A2F-U 16 / M16
Packing unit	1

Your Contact:

WISKA Hoppmann GmbH

Kisdorfer Weg 28 · 24568 Kaltenkirchen · Germany

☎ +49-4191-508-0 · 📠 +49-4191-508-209

contact@wiska.de · www.wiska.com

Tariff number	74198090
EAN number	4007686137132
ETIM-Classification	EC000441

Recommended accessories

OSET 16 / M16	50065634
OSSH-B-16	50065642

23.05.2026

Your Contact:

WISKA Hoppmann GmbH

Kisdorfer Weg 28 · 24568 Kaltenkirchen · Germany

☎ +49-4191-508-0 · 📠 +49-4191-508-209

contact@wiska.de · www.wiska.com

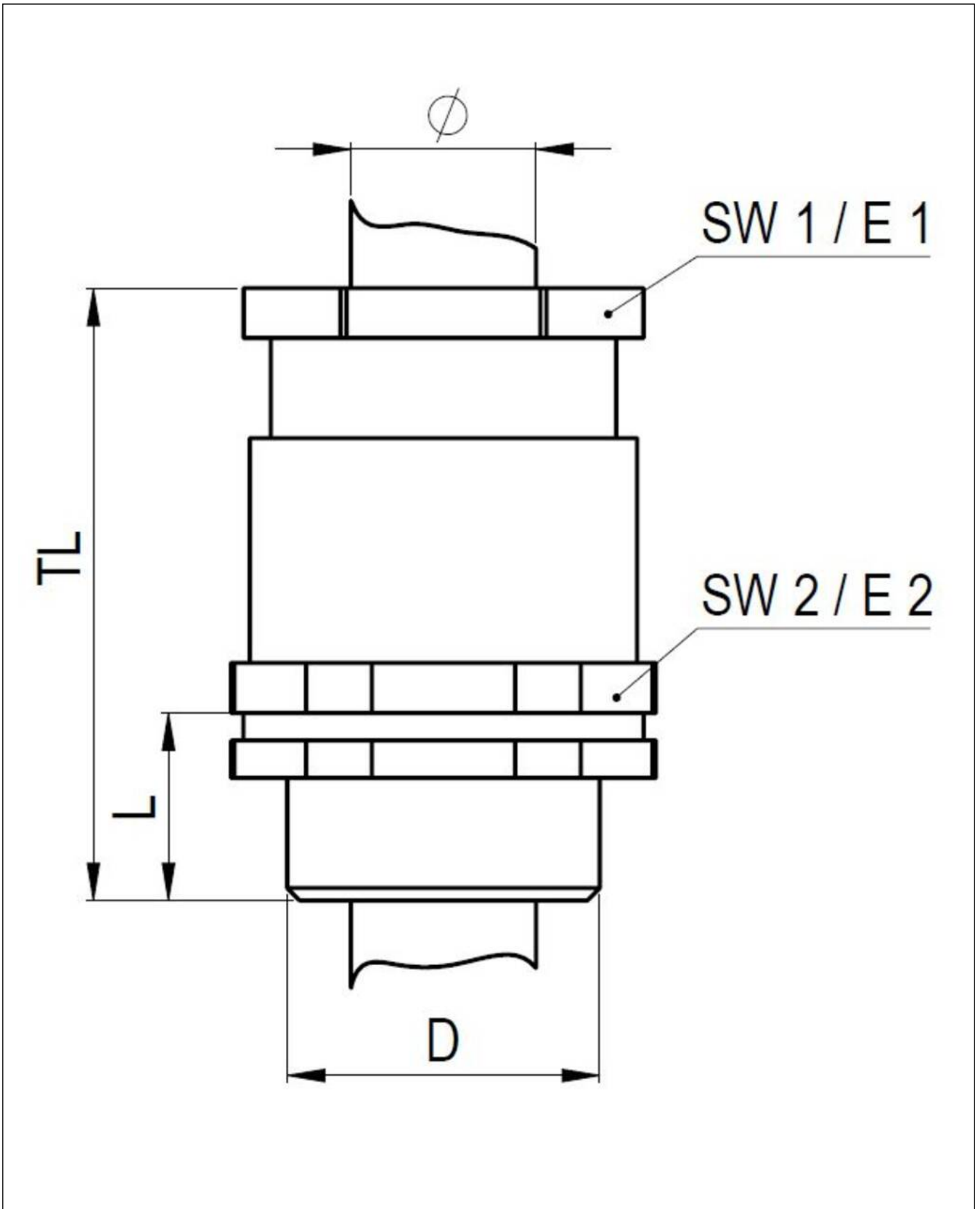

Your Contact:

WISKA Hoppmann GmbH

Kisdorfer Weg 28 · 24568 Kaltenkirchen · Germany

☎ +49-4191-508-0 · 📠 +49-4191-508-209

contact@wiska.de · www.wiska.com